

NEW 3-PIPE ECOi MF2 SERIES

SIMULTANEOUS HEATING AND COOLING VRF SYSTEM

<p>Internet Control Ready</p> <p>INTERNET CONTROL</p>	<p>Energy saving</p> <p>INVERTER+</p>	<p>Environmentally friendly refrigerant</p> <p>R410A</p>	<p>Down to -20 °C in heating mode</p> <p>OUTDOOR TEMPERATURE</p>	<p>5 year compressor warranty</p>
--	--	--	---	--

NEW



The New Panasonic 3-Pipe 6N Series offers the best to the most demanding customers.

- The new 3 way have only 1 size of chassis with very limited foot print (only 0.93 m²)
- 1 body for all sizes: H1.758 x W1.000 x D930 mm, for 8, 10, 12, 14 and 16 HP
- Maximum capacity size as 48HP by 3 units combinations (16 HP x 3 = 48 HP)
- Up to 52 indoor units connectable
- Maximun capacity ratio of 150%



Large combination of outdoor units, up to 48 HP

Inverter unit	System (HP)																					
	8	10	12	14	16	18	20	22	24	26	28	30	32	34	36	38	40	42	44	46	48	
8	1					1																
10		1				1	2	1	1	1				2	2	1	1	1				
12			1					1				1				1			1			
14				1						1			1			1				1		
16					1						1	1	1	2		1	1	1	2	2	2	3

High efficiency combination

Inverter unit	System (HP)					
	16	24	26	28	30	32
8	2	3	2	2	2	1
10			1			
12				1		2
14					1	
16						

Top of de market COP (at full load), standard efficiency

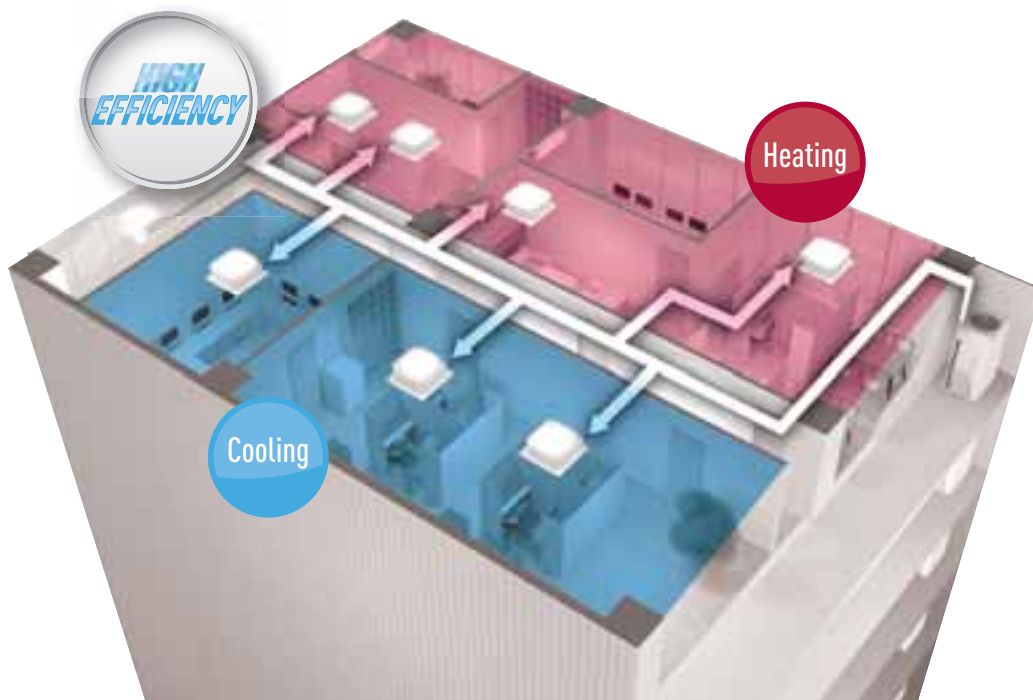
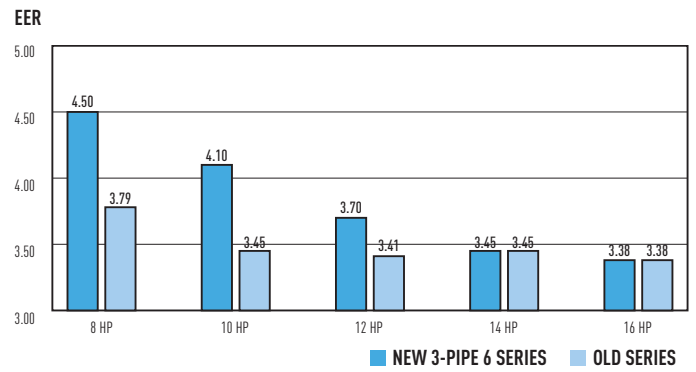
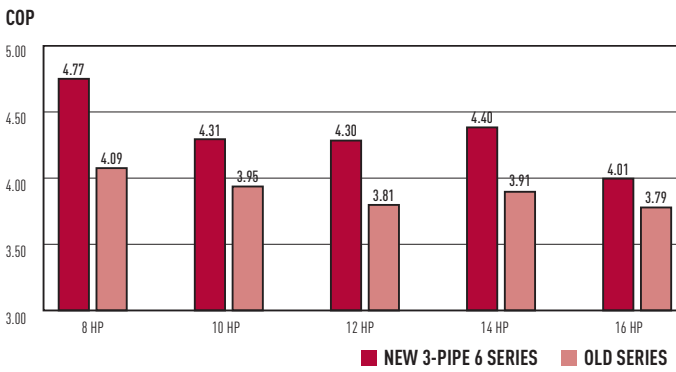

Connectable indoor/outdoor unit capacity ratio up to 150%

Extended operating range

Cooling operation range: The cooling operation range has been extended to -10 °C by changing the outdoor fan to an inverter type.

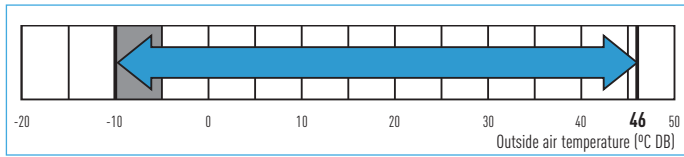

Heating operation range: Stable heating operation even with an outside air temperature of -20 °C. The heating operation range has been extended to -20 °C by use of a compressor with a high-pressure vessel.

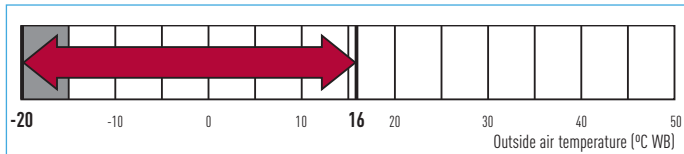

Wide temperature setting range

Wired remote control heating temperature setting range is 16 to 30 °C.

Increased piping lengths and design flexibility

Adaptable to various building types and sizes. Actual piping length: 180 m. Maximum piping length: 500 m.

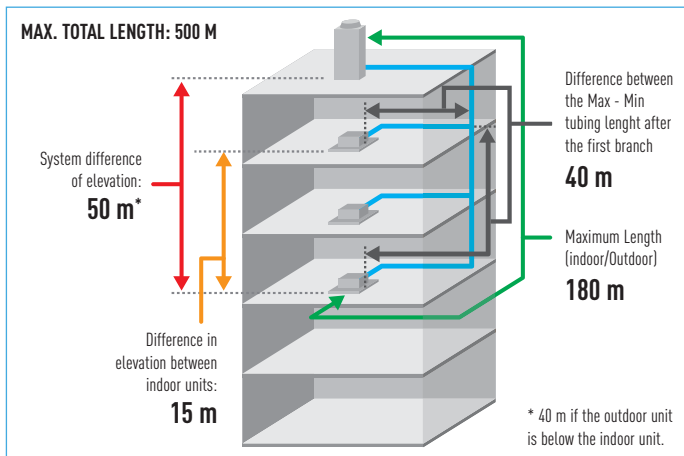

Non-stop operation during maintenance

Even when an indoor unit needs maintenance, the other indoor units can be kept operating by setting. (Not applicable for all situations)

Power suppression control for energy saving (Demand control)¹

The 3-Pipe ECOi MF2 series has a built-in demand function which uses the inverter characteristics. With this demand function, the power consumption can be set in three steps, and operation² at optimum performance is performed according to the setting and the power consumption. This function is useful to reduce the annual power consumption and to save electricity fees while maintaining comfort.

¹ An outdoor Seri-Para I/O unit is required for demand input.
² Setting is possible as 0% or in the range from 40 to 100% (in steps of 5%). At the time of shipping, setting has been done to the three steps of 0%, 70%, and 100%.

New Solenoid valve kit

- "Non-stop" Oil-recovery operation to gives more stable comfort air-conditioning control.
- New design to decrease chattering (bank the body 90 degrees)
- All now packaged in the same box.

3-PIPE CONTROL SOLENOID VALVE KIT

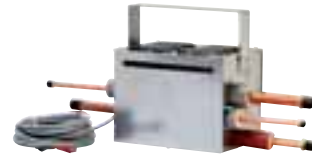

CZ-P56HR3

Up to 5.6 kW

CZ-P160HR3

From 5.7 to 16 kW

KIT-P56HR3

(CZ-P56HR3+CZ-CAPE2)

KIT-P160HR3

(CZ-P160HR3+CZ-CAPE2)

3-PIPE CONTROL PCB



3-Pipe control PCB CZ-CAPE2*

Must be added to the CZ-P56HR3 OR CZ-P160HR3.

* For wall mounted S-22MK2E5/S-28MK2E5/S-36MK2E5.

For S-45MK1E5/S-56MK1E5/S-73MK1E5/S-106MK1E5: CZ-CAPEK2.

Individual control of multiple indoor units with solenoid valve kits

- Any design and layout can be used in a single system.
- Cooling operation is possible up to an outdoor temperature of -10 °C.

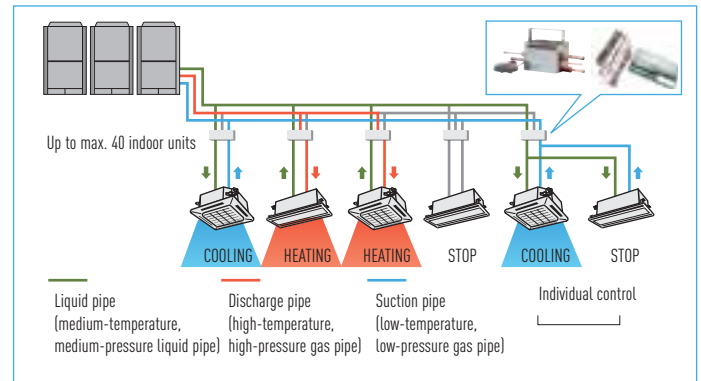

Compactness for superb space saving and low noise level

5 types of outdoor units with different capacities have been standardized to one compact casing size.

Uniquely constructed with two-part compartments, the upper room contains heat exchanger while the lower two-part stores compressors. The benefits are two-fold - superb space saving and low noise level.

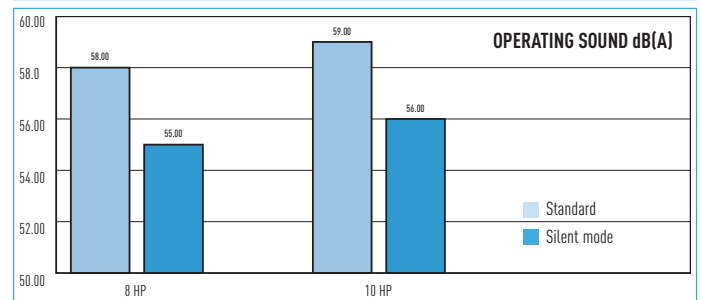
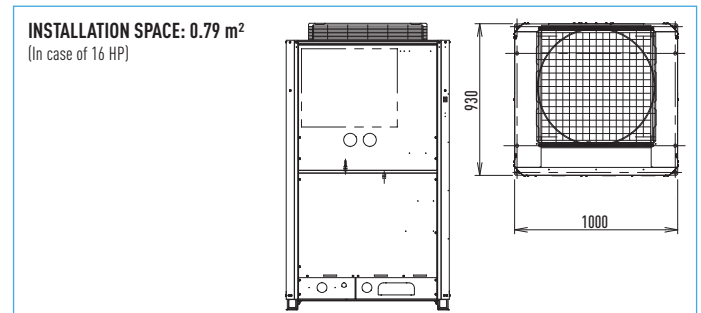

Excellent cost saving and realization of smaller piping size

By adoption of R410A with low pressure loss, it became possible to reduce the pipe sizes for discharge, suction and liquid pipes. This makes it possible to aim for reduced piping space, improved workability at the site, and reduction of the piping material costs.

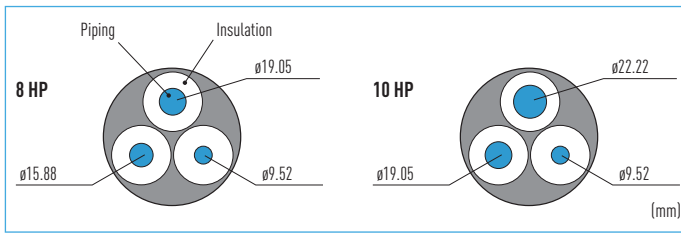

3-PIPE ECO <i>i</i> MF2			
HP	SUCTION PIPE	DISCHARGE PIPE	LIQUID PIPE
8	Ø 19.05	Ø 15.88	Ø 9.52
10	Ø 22.22	Ø 19.05	Ø 9.52

Extended compressor life

The total operation time of the compressors is monitored by a microcomputer, so that there is no imbalance for the operation times of all compressors in the same refrigerant system, and compressors with a shorter operation time are operated with preference.

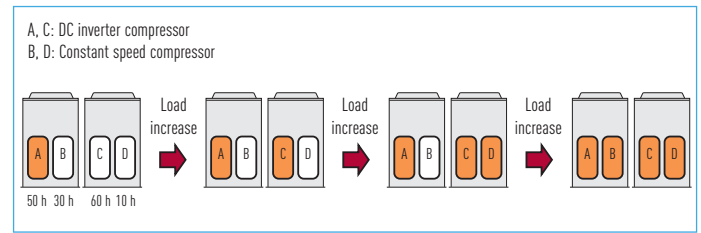

Piping design

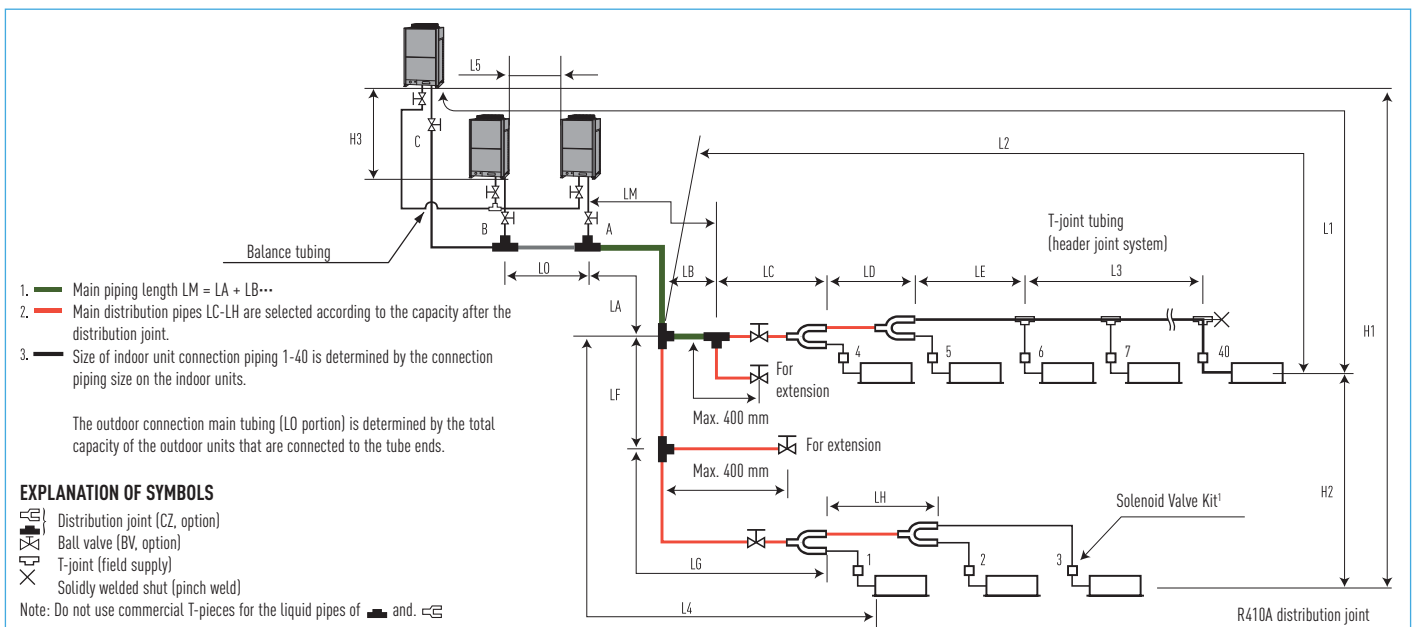

- Main piping length $LM = LA + LB + \dots$
 - Main distribution pipes LC-LH are selected according to the capacity after the distribution joint.
 - Size of indoor unit connection piping 1-40 is determined by the connection piping size on the indoor units.
- The outdoor connection main tubing (LO portion) is determined by the total capacity of the outdoor units that are connected to the tube ends.

EXPLANATION OF SYMBOLS

- Distribution joint (CZ, option)
- Ball valve (BV, option)
- T-joint (field supply)
- Solidly welded shut (pinch weld)

Note: Do not use commercial T-pieces for the liquid pipes of and .

- * Be sure to use R410A distribution joints for outdoor unit connections and piping branches.
- The connection between the indoor unit(s) and the solenoid valve kit(s) has three (3) types of methods. For further details, refer to the Section 2. 3-4. "Connecting Multiple Indoor Units to a Single Solenoid Valve Kit".

RANGES THAT APPLY TO REFRIGERANT PIPING LENGTHS AND TO DIFFERENCES IN INSTALLATION HEIGHTS

Items	Marks	Contents	Length (m)	
			Actual piping length	Equivalent piping length
Allowable piping length	L1	Max. piping length	≤180	≤200
	$\Delta L (L2-L4)$	Difference between the max. length and the min. length from the No. 1 distribution	≤40	
	LM	Max. length of main piping (at max. diameter)	— ³	
	$\phi 1, \phi 2-\phi 40$	Max. length of each distribution	≤30	
	$L1 + \phi 1 + \phi 2 + \dots + \phi 39 + \phi A + \phi B + LF + LG + LH$	Total max. piping length including length of each distribution (only liquid tubing)	≤500 ⁴	
	L5	Distance between outdoor units	≤10	
Allowable elevation difference	H1	When outdoor unit is installed higher than indoor unit	≤50	
		When outdoor unit is installed lower than indoor unit	≤40	
	H2	Max. difference between indoor units	≤15	
Allowable length of joint tubing	H3	Max. difference between outdoor units	≤4	
		L3	T-joint tubing (field-supply); Max. tubing length between the first T-joint and solidly welded-shut end point	≤2

L = Length, H = Height

- The outdoor connection main tubing (LO portion) is determined by the total capacity of the outdoor units that are connected to the tube ends.
- If the longest tubing length (L1) exceeds 90 m (equivalent length), increase the sizes of the main tubes (LM) by 1 rank for the discharge tubes, suction tubes, and narrow tubes. (field supplied).
- If the longest main tube length (LM) exceeds 50 m, increase the main tube size at the portion before 50 m by 1 rank for the suction tubes and discharge tubes. (field supplied). [For the portion that exceeds 50 m, set based on the main tube sizes (LA) listed in the table on the following page].
- 24 HP - 3 OHP of high efficiency combination is 300 m.



8-16 HP // 3-PIPE ECOi MF2 SERIES

WITH SIMULTANEOUS HEATING AND COOLING OPERATION HEAT RECOVERY TYPE

ECOi 3-Pipe is one of the most advanced VRF systems available. Not only offering high-efficiency and performance for simultaneous heating and cooling, Its sophisticated design makes installation and maintenance much easier.

- Conforms to COP 4.77 as the top class in the industry (Average cooling and heating value for 8 HP outdoor unit).
- Simultaneous cooling or heating operation for up to 52 indoor units.
- Small installation space, top class in the industry.
- Rotation operation function and back-up operation function provided.

Internet
Control
Ready

INTERNET CONTROL

Environmentally
friendly
refrigerant

R410A

Down to
-20 °C in
heating mode

OUTDOOR TEMPERATURE

5 year
compressor
warranty

OPTIONAL

TECHNICAL FOCUS

- STANDARDIZATION OF O_U TO ONE COMPACT CASING SIZE
- IMPROVED OPERATION EFFICIENCY
- THE CONSTANT-SPEED COMPRESSOR ADOPTS A HIGH-PERFORMANCE INTERNAL HIGH-PRESSURE SCROLL
- IMPROVEMENT OF THE HEAT EXCHANGER
- RELAYOUT OF STRUCTURAL PARTS
- CLOSE SIDE-BY-SIDE INSTALLATION IS POSSIBLE

HP	8		10		12		14		16		
MODEL NAME	U-8MF2E8		U-10MF2E8		U-12MF2E8		U-14MF2E8		U-16MF2E8		
Power supply	380 / 400 / 415 V - Three Phase / 50 Hz										
Cooling capacity	kW	22.4	28.0	33.5	40.0	45.0					
	BTU/h	76,500	95,600	114,300	136,500	153,600					
EER	W/W	4.50	4.10	3.70	3.45	3.38					
Running current	380 / 400 / 415 V	A	8.60 / 8.17 / 7.96	11.3 / 10.8 / 10.6	15.1 / 14.5 / 14.1	19.7 / 18.9 / 18.4	22.5 / 21.6 / 21.0				
Power input	kW	4.98	6.83	9.05	11.59	13.31					
Heating capacity	kW	25.0	31.5	37.5	45.0	50.0					
	BTU/h	85,300	107,500	128,000	153,600	170,600					
COP	W/W	4.77	4.55	4.30	4.41	4.03					
Running current	380 / 400 / 415 V	A	8.95 / 8.50 / 8.28	11.6 / 11.0 / 10.7	14.7 / 14.1 / 13.8	17.0 / 16.4 / 15.9	20.7 / 19.9 / 19.4				
Power input	kW	5.24	6.92	8.72	10.2	12.4					
Dimensions	H x W x D	mm	1758 x 1000 x 930	1758 x 1000 x 930	1758 x 1000 x 930	1758 x 1000 x 930	1758 x 1000 x 930				
Net weight	Kg	269	269	314	322	322					
Air circulation	m ³ /min	158	178	212	212	212					
Refrigerant amount at shipment	Kg	8.3	8.5	8.8	9.3	9.3					
Piping connections	Suction pipe	mm (Inch)	Ø 22.22 (7/8)	Ø 25.40 (1)	Ø 28.58 (1-1/8)	Ø 25.40 (1)	Ø 28.58 (1-1/8)				
	Discharge pipe	mm (Inch)	Ø 15.88 (5/8)	Ø 19.05 (3/4)	Ø 19.05 (3/4)	Ø 22.22 (7/8)	Ø 22.22 (7/8)				
	Liquid pipe	mm (Inch)	Ø 9.52 (3/8)	Ø 9.52 (3/8)	Ø 12.70 (1/2)	Ø 12.70 (1/2)	Ø 12.70 (1/2)				
	Balance pipe	mm (Inch)	Ø 6.35 (1/4)	Ø 6.35 (1/4)	Ø 6.35 (1/4)	Ø 6.35 (1/4)	Ø 6.35 (1/4)				
Ambient temperature operating range	Cooling/Dry: -10 °C~+46 °C (DB). Heating: -20 °C~+18 °C (WB) Simultaneous operation: -10 °C~+24 °C (DB)										
Sound pressure level	High / Low	dBA	57.0 / 54.0	59.0 / 56.0	60.0 / 58.0	62.0 / 59.0	62.0 / 59.0				
Sound power level	Normal mode	dB	71.5 / 68.5	73.5 / 70.5	75.5 / 72.5	76.5 / 73.5	76.5 / 73.5				

GLOBAL REMARKS	Rated conditions:	
	Cooling	Heating
	Indoor air temperature	27 °C DB / 19 °C WB
Outdoor air temperature	35 °C DB / 24 °C WB	7 °C DB / 6 °C WB

Specifications subject to change without notice.

NEW



System limitations

Max. number of combined outdoor units	3
Max. HP of combined outdoor units	135 kW (48 HP)
Max. number of connectable indoor units	52
Indoor/outdoor unit capacity ratio	50 - 150%

Additional refrigerant charge

LIQUID PIPING SIZE	AMOUNT OF REFRIGERANT CHARGE/m (g/m)	LIQUID PIPING SIZE	AMOUNT OF REFRIGERANT CHARGE/m (g/m)
Ø 6.35	26	Ø 19.05	259
Ø 9.52	56	Ø 22.22	366
Ø 12.7	128	Ø 25.40	490
Ø 15.88	185		

Refrigerant piping

PIPING SIZE (mm)			
O MATERIAL		1/2 H, H MATERIAL	
Outer diameter	Wall thickness	Outer diameter	Wall thickness
Ø 6.35	0.8	Ø 25.4	1.0
Ø 9.52	0.8	Ø 28.58	1.0
Ø 12.7	0.8	Ø 31.75	1.1
Ø 15.88	1.0	Ø 38.1	over 1.35
Ø 19.05	1.0	Ø 41.28	over 1.45
Ø 22.22	1.15		

Note: When pipe bending is to be performed, the bending radius shall be at least 4 times the outer diameter. Also, take sufficient care to prevent pipe collapse and damage at the time of bending.

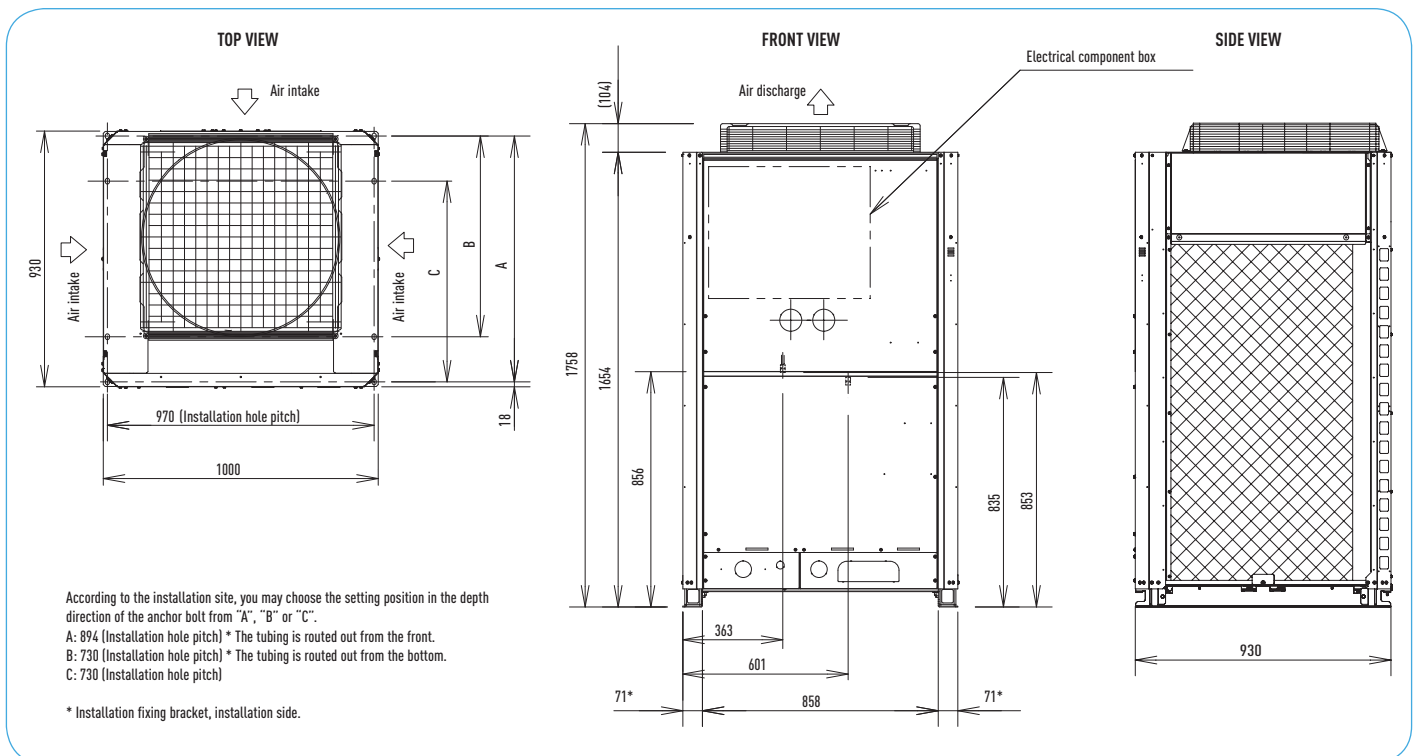



3-PIPE ECOi MF2 SERIES // COMBINATION FROM 18 TO 48 HP

WITH SIMULTANEOUS HEATING AND COOLING OPERATION HEAT RECOVERY TYPE

ECOi 3-Pipe is one of the most advanced VRF systems available. Not only offering high-efficiency and performance for simultaneous heating and cooling, Its sophisticated design makes installation and maintenance much easier.

- Conforms to COP 4,63 as the top class in the industry (Average cooling and heating value for 8 HP outdoor unit).
- Simultaneous cooling or heating operation for up to 52 indoor units.
- Small installation space, top class in the industry.
- Rotation operation function and back-up operation function provided.

Internet Control Ready

INTERNET CONTROL

Environmentally friendly refrigerant

R410A

Down to -20 °C in heating mode

OUTDOOR TEMPERATURE

5 year compressor warranty

OPTIONAL

TECHNICAL FOCUS

- STANDARDIZATION OF O_U TO ONE COMPACT CASING SIZE
- IMPROVED OPERATION EFFICIENCY
- THE CONSTANT-SPEED COMPRESSOR ADOPTS A HIGH-PERFORMANCE INTERNAL HIGH-PRESSURE SCROLL
- IMPROVEMENT OF THE HEAT EXCHANGER
- RELAYOUT OF STRUCTURAL PARTS
- CLOSE SIDE-BY-SIDE INSTALLATION IS POSSIBLE

HP		18	20	22	24	26	28	30
MODEL NAME		U-8MF2E8 U-10MF2E8	U-8MF2E8 U-12MF2E8	U-8MF2E8 U-14MF2E8	U-8MF2E8 U-16MF2E8	U-12MF2E8 U-14MF2E8	U-14MF2E8 U-14MF2E8	U-14MF2E8 U-16MF2E8
Power supply		380 / 400 / 415 V - Three Phase / 50 Hz						
Cooling capacity	kW	50.4	56.0	61.5	68.0	73.0	78.5	85.0
	BTU/h	172,000	191,100	209,900	232,100	249,100	267,900	290,100
EER	W/W	4.27	3.97	3.71	3.72	3.54	3.39	3.41
Running current	380 / 400 / 415 V A	19.7 / 18.9 / 18.4	23.8 / 22.9 / 22.3	27.5 / 26.5 / 25.8	31.4 / 30.2 / 29.4	34.2 / 32.8 / 32.0	38.1 / 36.6 / 35.7	42.1 / 40.4 / 39.4
Power input	kW	11.8	14.1	16.6	18,29	20,64	23,18	24,90
Heating capacity	kW	56.5	63.0	69.0	76.5	81.5	87.5	95.0
	BTU/h	192,800	215,000	235,500	261,100	278,200	298,600	324,200
COP	W/W	4.63	4.47	4.57	4.20	4.38	4.49	4.20
Running current	380 / 400 / 415 V A	20.4 / 19.6 / 19.1	23.8 / 22.9 / 22.3	25.2 / 24.2 / 23.6	30.4 / 29.2 / 28.5	31.1 / 29.8 / 29.1	32.6 / 31.3 / 30.5	37.7 / 36.2 / 35.3
Power input	kW	12.2	14.1	15.1	18.2	18.6	19.5	22.6
Dimensions	H x W x D	mm 1758 x 2060 x 930	1758 x 2060 x 930	1758 x 2060 x 930	1758 x 2060 x 930	1758 x 2060 x 930	1758 x 2060 x 930	1758 x 2060 x 930
Net weight	Kg	538	538	591	591	636	644	644
Air circulation	m ³ /min	336	370	370	370	424	424	424
Refrigerant amount at shipment	Kg	16.8	17.1	17.6	17.6	18.1	18.6	18.6
Piping connections	Suction pipe	mm (Inch) Ø 28.58 (1-1/8)	Ø 28.58	Ø 28.58	Ø 28.58	Ø 31.75 (1-1/4)	Ø 31.75	Ø 31.75
	Discharge pipe	mm (Inch) Ø 22.22 (7/8)	Ø 22.22	Ø 25.40 (1)	Ø 25.40	Ø 25.40	Ø 28.58	Ø 28.58
	Liquid pipe	mm (Inch) Ø 15.88 (5/8)	Ø 15.88	Ø 15.88	Ø 15.88	Ø 19.05 (3/4)	Ø 19.05	Ø 19.05
	Balance pipe	mm (Inch) Ø 6.35 (1/4)	Ø 6.35 (1/4)	Ø 6.35 (1/4)	Ø 6.35 (1/4)	Ø 6.35 (1/4)	Ø 6.35 (1/4)	Ø 6.35 (1/4)
Ambient temperature operating range		Cooling/Dry: -10 °C~+46 °C (DB). Heating: -20 °C~+18 °C (WB) Simultaneous operation: -10 °C~+24 °C (DB)						
Sound pressure level	High / Low	dBA 62.0 / 59.0	62.5 / 59.5	63.5 / 60.5	63.5 / 60.5	65.0 / 62.0	65.5 / 62.5	65.5 / 62.5
Sound power level	Normal mode	dB 76.5 / 73.5	77.0 / 74.0	78.0 / 75.0	78.0 / 75.0	79.5 / 76.5	80.0 / 77.0	80.0 / 77.0

GLOBAL REMARKS	Rated conditions:	Cooling	Heating
	Indoor air temperature	27 °C DB / 19 °C WB	20 °C DB
	Outdoor air temperature	35 °C DB / 24 °C WB	7 °C DB / 6 °C WB

Specifications subject to change without notice.

NEW



150%
CAPACITY
RATIO

32	34	36	38	40	42	44	46	48
U-16MF2E8 U-16MF2E8	U-8MF2E8 U-12MF2E8 U-14MF2E8	U-8MF2E8 U-14MF2E8 U-14MF2E8	U-8MF2E8 U-14MF2E8 U-16MF2E8	U-8MF2E8 U-16MF2E8 U-16MF2E8	U-14MF2E8 U-14MF2E8 U-14MF2E8	U-14MF2E8 U-14MF2E8 U-16MF2E8	U-14MF2E8 U-16MF2E8 U-16MF2E8	U-16MF2E8 U-16MF2E8 U-16MF2E8

380 / 400 / 415 V - Three Phase / 50 Hz

90.0	96.0	101.0	107.0	113.0	118.0	124.0	130.0	135.0
307,200	327,600	344,700	365,200	385,700	402,700	423,200	443,700	460,800
3,38	3,75	3,59	3,58	3,58	3,39	3,40	3,40	3,38
44.9 / 43.1 / 42.0	43.4 / 41.7 / 40.0	47.1 / 45.2 / 44.1	50.6 / 48.6 / 47.4	54.1 / 52.0 / 50.0	57.5 / 55.2 / 53.8	61.1 / 58.6 / 57.2	65.2 / 62.7 / 61.1	67.4 / 64.7 / 63.1
26,62	25,62	28,16	29,88	31,60	34,77	36,49	38,21	39,93
100.0	108.0	113.0	119.0	127.0	132.0	138.0	145.0	150.0
341,300	368,600	385,700	406,100	433,400	450,500	471,000	494,900	511,900
4.03	4.44	4.52	4.33	4.12	4.46	4.30	4.14	4.03
41.7 / 40.1 / 39.1	41.0 / 39.4 / 38.4	41.6 / 39.9 / 38.9	46.1 / 44.3 / 43.1	52.2 / 49.6 / 47.8	49.3 / 47.3 / 46.1	53.8 / 51.6 / 50.3	58.8 / 56.5 / 55.0	62.6 / 60.1 / 58.6
24.8	24.3	25.0	27.5	30.8	29.6	32.1	35.0	37.2
1758 x 2060 x 930	1758 x 3120 x 930	1758 x 3120 x 930	1758 x 3120 x 930	1758 x 3120 x 930	1758 x 3120 x 930	1758 x 3120 x 930	1758 x 3120 x 930	1758 x 3120 x 930
644	905	913	913	913	966	966	966	966
424	582	582	582	582	636	636	636	636
18.6	26.4	26.9	26.9	26.9	27.9	27.9	27.9	27.9
Ø 31.75	Ø 31.75	Ø 38.10 (1-1/2)	Ø 38.10	Ø 38.10	Ø 38.10	Ø 38.10	Ø 38.10	Ø 38.10
Ø 28.58	Ø 28.58	Ø 28.58	Ø 31.75	Ø 31.75	Ø 31.75	Ø 31.75	Ø 31.75	Ø 31.75
Ø 19.05	Ø 19.05	Ø 19.05	Ø 19.05	Ø 19.05	Ø 19.05	Ø 19.05	Ø 19.05	Ø 19.05
Ø 6.35 (1/4)	Ø 6.35 (1/4)	Ø 6.35 (1/4)	Ø 6.35 (1/4)	Ø 6.35 (1/4)	Ø 6.35 (1/4)	Ø 6.35 (1/4)	Ø 6.35 (1/4)	Ø 6.35 (1/4)

Cooling/Dry: -10 °C~+46 °C (DB). Heating: -20 °C~+18 °C (WB) Simultaneous operation: -10 °C~+24 °C (DB)

65.5 / 62.5	65.5 / 62.5	66.0 / 63.0	66.0 / 63.0	66.0 / 63.0	67.0 / 64.0	67.0 / 64.0	67.0 / 64.0	67.0 / 64.0
80.0 / 77.0	80.0 / 77.0	80.5 / 77.5	80.5 / 77.5	80.5 / 77.5	81.5 / 78.5	81.5 / 78.5	81.5 / 78.5	81.5 / 78.5

SYSTEM EXAMPLE

CONNECTION

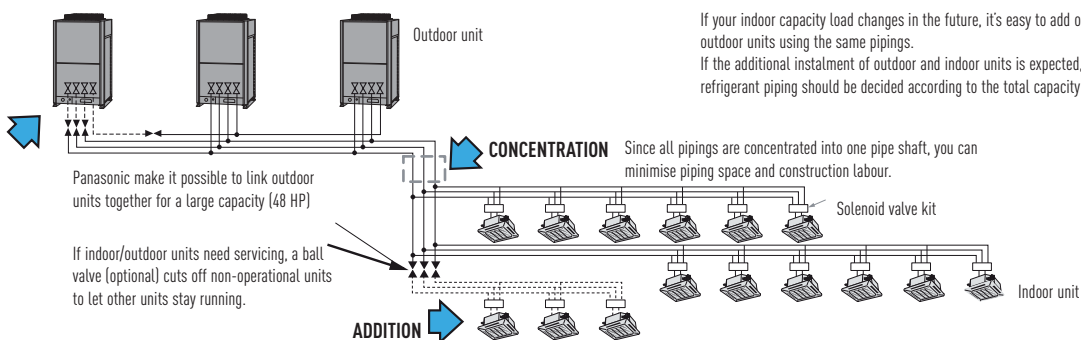

Panasonic make it possible to link outdoor units together for a large capacity (48 HP)

If indoor/outdoor units need servicing, a ball valve (optional) cuts off non-operational units to let other units stay running.

CONCENTRATION Since all pipings are concentrated into one pipe shaft, you can minimise piping space and construction labour.

If your indoor capacity load changes in the future, it's easy to add on both indoor and outdoor units using the same pipings.

If the additional instalment of outdoor and indoor units is expected, the size of refrigerant piping should be decided according to the total capacity after the addition.



3-PIPE ECOi MF2 SERIES // HIGH EFFICIENCY COMBINATION 16 TO 32 HP

WITH SIMULTANEOUS HEATING AND COOLING OPERATION HEAT RECOVERY TYPE

ECOi 3-Pipe is one of the most advanced VRF systems available. Not only offering high-efficiency and performance for simultaneous heating and cooling, Its sophisticated design makes installation and maintenance much easier.

- Conforms to COP 4.76 as the top class in the industry (Average cooling and heating value for 8 HP outdoor unit).
- Simultaneous cooling or heating operation for up to 52 indoor units.
- Small installation space, top class in the industry.
- Rotation operation function and back-up operation function provided.

Internet
Control
Ready

INTERNET CONTROL

Environmentally
friendly
refrigerant

R410A

Down to
-20 °C in
heating mode

OUTDOOR TEMPERATURE

5 year
compressor
warranty

OPTIONAL

TECHNICAL FOCUS

- STANDARDIZATION OF O_U TO ONE COMPACT CASING SIZE
- IMPROVED OPERATION EFFICIENCY
- THE CONSTANT-SPEED COMPRESSOR ADOPTS A HIGH-PERFORMANCE INTERNAL HIGH-PRESSURE SCROLL
- IMPROVEMENT OF THE HEAT EXCHANGER
- RELAYOUT OF STRUCTURAL PARTS
- CLOSE SIDE-BY-SIDE INSTALLATION IS POSSIBLE

HP			16	24	26	28	30	32
MODEL NAME			U-8MF2E8 U-8MF2E8	U-8MF2E8 U-8MF2E8 U-8MF2E8	U-8MF2E8 U-8MF2E8 U-10MF2E8	U-8MF2E8 U-8MF2E8 U-12MF2E8	U-8MF2E8 U-8MF2E8 U-14MF2E8	U-8MF2E8 U-12MF2E8 U-12MF2E8
Power supply			380 / 400 / 415 V - Three Phase / 50 Hz					
Cooling capacity	kW		45.0	68.0	73.0	78.5	85.0	90.0
	BTU/h		153,600	232,100	249,100	267,900	290,100	307,200
EER	W/W		4.50	4.47	4.32	4.11	3.94	3.90
Running current	380 / 400 / 415 V	A	17.3 / 16.4 / 16.0	26.2 / 24.9 / 24.3	28.5 / 27.4 / 26.7	32.2 / 31.0 / 30.2	37.0 / 35.5 / 34.6	38.9 / 37.4 / 36.4
Power input	kW		10.0	15.2	16.9	19.1	21,55	23,08
Heating capacity	kW		50.0	76.5	81.5	87.5	95.0	100.0
	BTU/h		170,600	261,100	278,200	298,600	324,200	341,300
COP	W/W		4.76	4.72	4.68	4.56	4.59	4.41
Running current	380 / 400 / 415 V	A	17.9 / 17.0 / 16.6	27.7 / 26.3 / 26.6	29.4 / 27.9 / 27.5	32.4 / 31.1 / 30.4	35.0 / 33.6 / 32.7	38.3 / 36.8 / 35.9
Power input	kW		10,48	16,04	17,76	19,15	23,40	22,68
Dimensions (Combination)	H x W x D	mm	1758 x 2060 x 930	1758 x 3120 x 930	1758 x 3120 x 930	1758 x 3120 x 930	1758 x 3120 x 930	1758 x 3120 x 930
Net weight		Kg	538	807	807	852	860	897
Air circulation		m ³ /min	316	474	494	528	528	582
Refrigerant amount at shipment		Kg	16.6	24.9	25.1	25.4	25.9	25.9
Piping connections	Suction pipe	mm	Ø 28.58	Ø 28.58	Ø 31.75	Ø 31.75	Ø 31.75	Ø 31.75
	Discharge pipe	mm	Ø 22.22	Ø 25.40	Ø 25.40	Ø 28.58	Ø 28.58	Ø 28.58
	Liquid pipe	mm	Ø 12.70	Ø 15.88	Ø 19.05	Ø 19.05	Ø 19.05	Ø 19.05
	Balance pipe	mm	Ø 6.35	Ø 6.35	Ø 6.35	Ø 6.35	Ø 6.35	Ø 6.35
Ambient temperature operating range	Cooling/Dry: -10 °C~+46 °C (DBT). Heating: -20 °C~+18 °C (WBT) Simultaneous operation: -10 °C~+24 °C (DBT)							
Sound pressure level	High / Low	dB(A)	60.5 / 57.5	62.0 / 59.0	63.0 / 60.0	64.0 / 61.0	64.5 / 61.5	65.0 / 62.0
Sound power level	Normal mode	dB	75.0 / 72.0	76.5 / 73.5	77.5 / 74.5	78.5 / 75.5	79.0 / 76.0	79.5 / 76.5

GLOBAL REMARKS	Rated conditions:	Cooling	Heating
	Indoor air temperature	27 °C DB / 19 °C WB	20 °C DB
	Outdoor air temperature	35 °C DB / 24 °C WB	7 °C DB / 6 °C WB

Specifications subject to change without notice.

NEW



Top of de market COP (at full load), standard efficiency

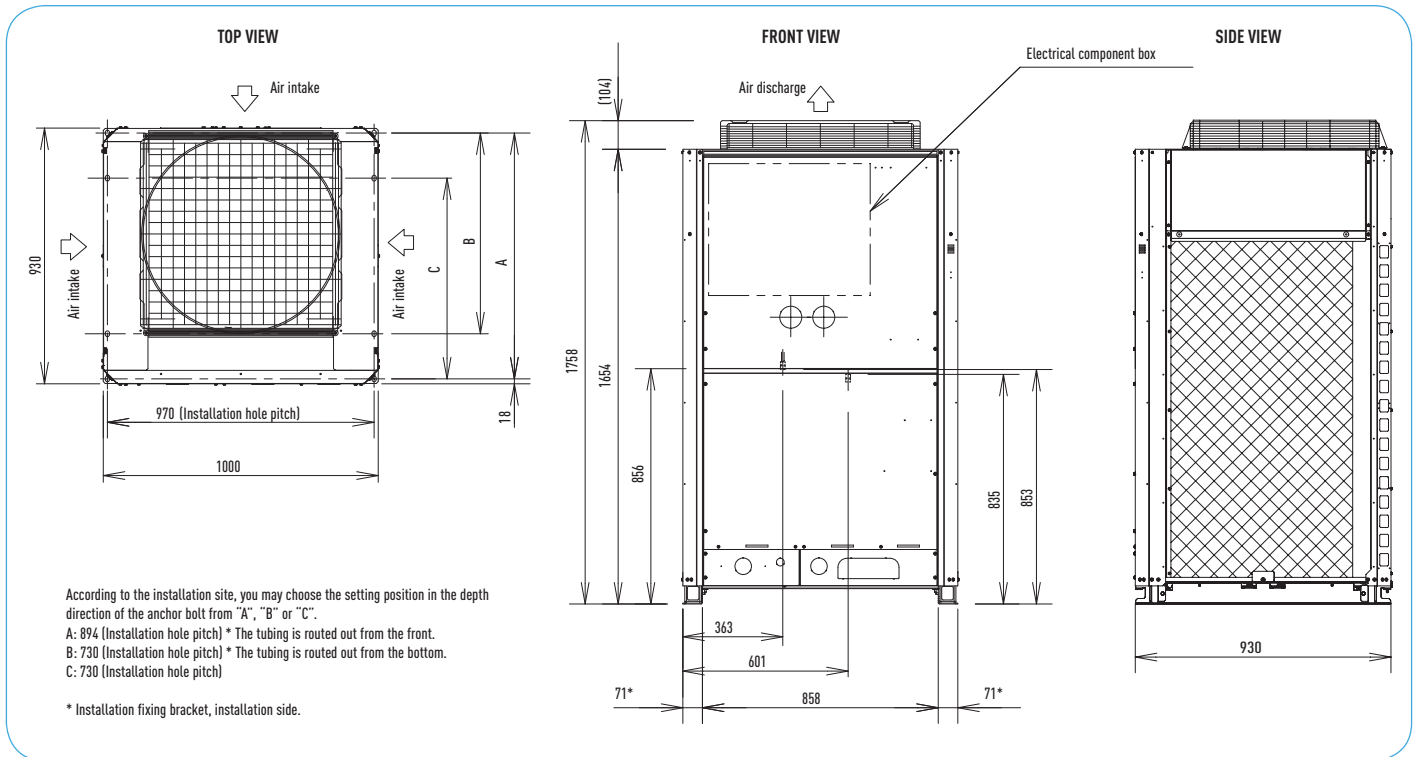
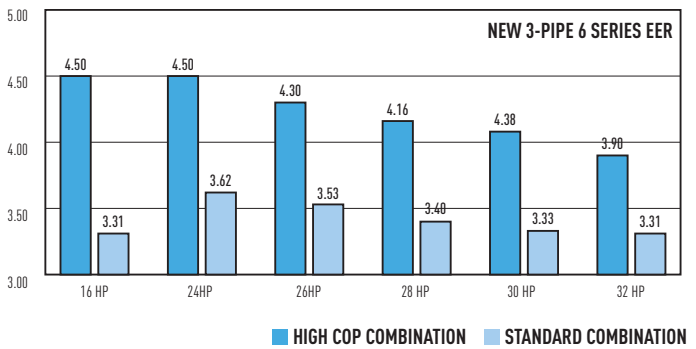
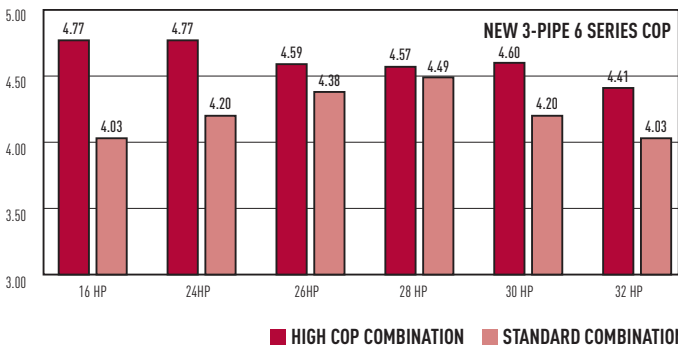

4. Installation Instructions

Outdoor Unit

4-1. Selecting the Installation Site for Outdoor Unit

AVOID:

- heat sources, exhaust fans, etc.
- damp, humid or uneven locations
- indoors (no-ventilation location)

DO:

- choose a place as cool as possible.
- choose a place that is well ventilated.
- allow enough room around the unit for air intake/exhaust and possible maintenance.

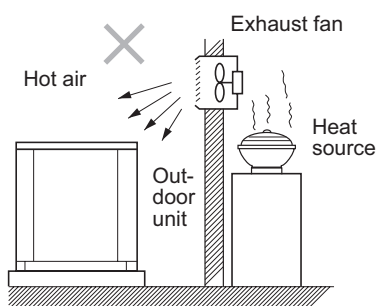

Fig. 4-1

Installation Space

Install the outdoor unit where there is enough space for ventilation. Otherwise the unit may not operate properly. Fig. 4-2 shows the minimum space requirement around the outdoor units when 3 sides are open and only 1 side is shuttered, with open space above the unit. The mounting base should be concrete or a similar material that allows for adequate drainage. Make provisions for anchor bolts, platform height, and other site-specific installation requirements.



CAUTION

- Leave space open above the unit.
- Construct louvers or other openings in the wall, if necessary, to ensure adequate ventilation.

NOTE

- Do not do any wiring or tubing within 30 cm of the front panel, because this space is needed as a servicing space for the compressor.
 - Ensure a base height of 100 mm or more to ensure that drainage water does not accumulate and freeze around the bottom of the unit.
 - If installing a drain pan, install the drain pan prior to installing the outdoor unit.
- * Make sure there is at least 150 mm between the outdoor unit and the ground.
- Also, the direction of the tubing and electrical wiring should be from the front of the outdoor unit.

Example of installation of 2 units
(when 3 sides are open and only 1 side is shuttered)

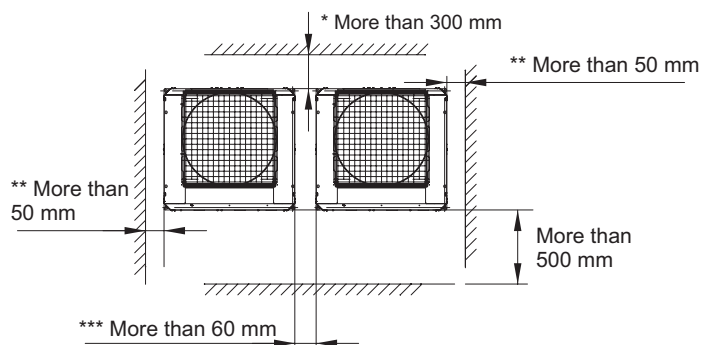

- * Make a walk-in space behind the unit to erase maintenance and servicing.
- ** When setting the anchor bolt to position "B" or "C" (See Fig. 4-3), make the space between the unit and the wall more than 250 mm for installation operation.
- *** When setting the anchor bolt to position "B" or "C" (See Fig. 4-3), make the space between the outdoor units more than 180 mm for installation operation.

Fig. 4-2

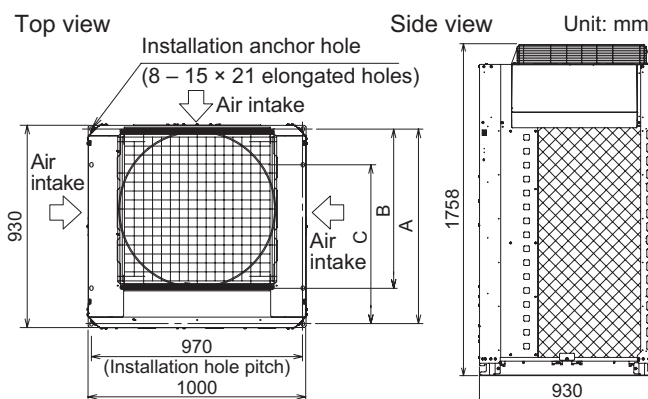



- * According to the installation site, you may choose the setting position in the depth direction of the anchor bolt from "A", "B" or "C".
A : 894 (Installation hole pitch) * For removing tube forward
B : 730 (Installation hole pitch) * For removing the tube downward
C : 730 (Installation hole pitch)

Fig. 4-3

1. Outdoor Unit

1-5. Noise Criterion Curves

Standard mode 
 Quiet mode 

U-8MF2E8, U-10MF2E8, U-12MF2E8, U-14MF2E8, U-16MF2E8

MODEL : U-8MF2E8
 SOUND LEVEL : 57.0
 db (A) (Quiet mode 54.0)
 CONDITION : 1 m in front at height of 1.5 m

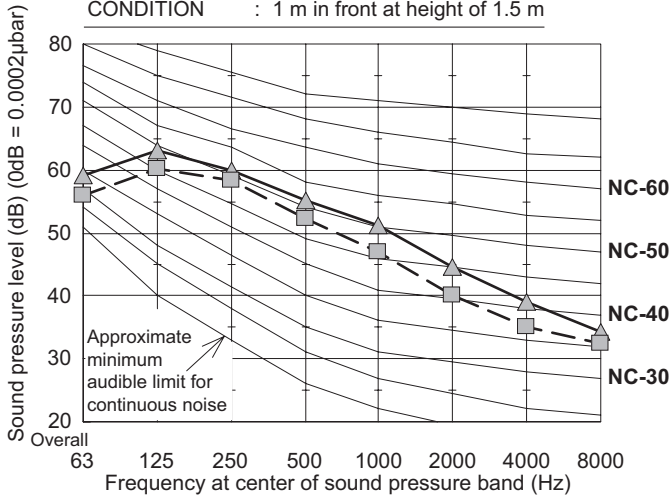

MODEL : U-10MF2E8
 SOUND LEVEL : 59.0
 db (A) (Quiet mode 56.0)
 CONDITION : 1 m in front at height of 1.5 m

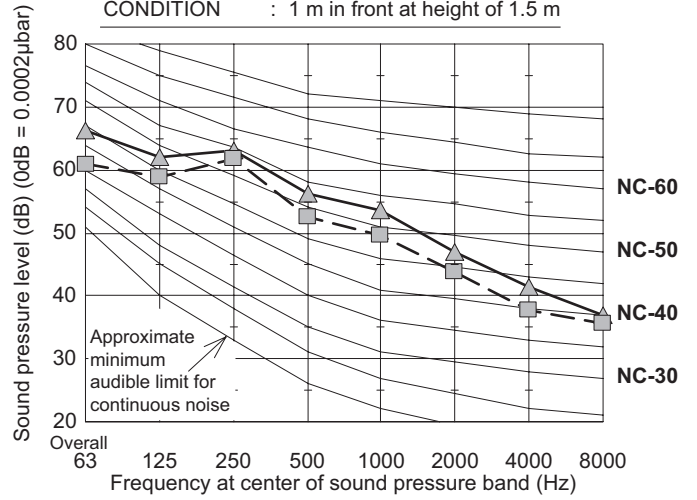

MODEL : U-12MF2E8
 SOUND LEVEL : 61.0
 db (A) (Quiet mode 58.0)
 CONDITION : 1 m in front at height of 1.5 m

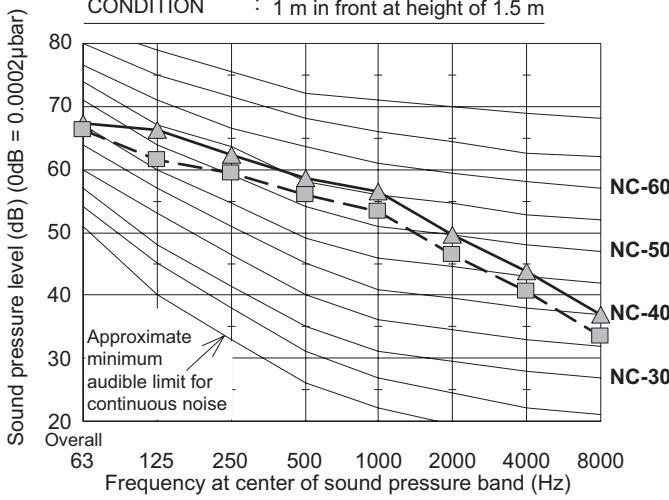

MODEL : U-14MF2E8
 SOUND LEVEL : 62.0
 db (A) (Quiet mode 59.0)
 CONDITION : 1 m in front at height of 1.5 m

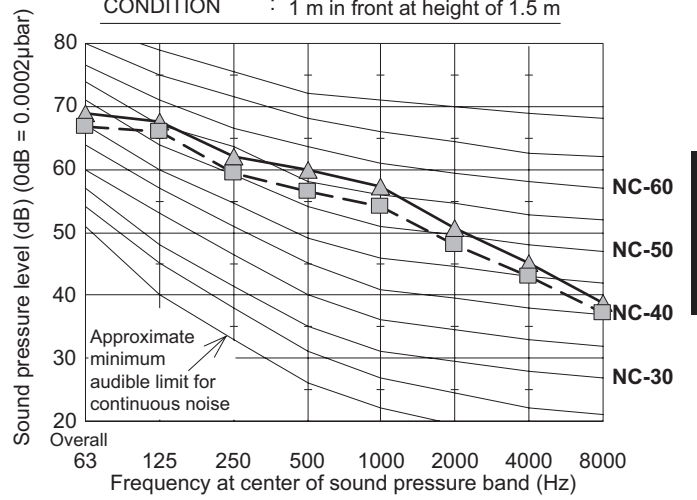

MODEL : U-16MF2E8
 SOUND LEVEL : 62.0
 db (A) (Quiet mode 59.0)
 CONDITION : 1 m in front at height of 1.5 m

